

ICON

LEGEND & DESCRIPTION

Material	HSS	High Speed Steel	HSS Co5	5% Cobalt High Speed Steel	HSS Co8	8% Cobalt High Speed Steel	HSS Co8e	8% Cobalt HSS, Eccentric Relief Sharpening		
	HSS V3	3% Vanadium High Speed Steel	SOLID CARBIDE	9-10% Cobalt, 0.2-0.8 µm Grain size.	CARBON STEEL	Carbon Steel				
Finish	BLUE FINISH	Steam (HOMO) Temper	BRIGHT FINISH	No Surface Treatment	BRIGHT FINISH WITH TIN TIP	TIN Coated for a length of 4 x diameter				
	GOLD OXIDE	Steam (HOMO) Temper Straw Colour	TIAN	Titanium Aluminium Nitride (Black Finish)	TIN	Titanium Nitride (Gold Finish)	X.TREME	TiAlN suited to Solid Carbide (Violet -grey Finish)		
Type	TYPE N	Type N Standard	TYPE W	Type W For Soft Materials	TYPE H	Type H For Hard Materials	TYPE FS	Parabolic Flute Strong Core		
	CBA	Colour Band Application								
Milling Profile		Staggered Teeth Side & Face Cutters		Straight Teeth Side & Face Cutters						
		Fine Pitch Knuckle Type Roughing Profile		Coarse Pitch Knuckle Type Roughing Profile		Fine Pitch Flat Crest Rough Semi-finishing Profile		Coarse Pitch Flat Crest Rough Semi-finishing Profile		
Standard	ISO 529	ISO Standard 529	DIN 371	DIN Standard 371	WORKS STD.	Factory Specifications				
	RF	Refined Flute	QS	Quick Spiral	H 7	Reamer to produce H7 Tolerance				
Shank		Flatted Shank h6 Tolerance		Plain Shank h7 Tolerance		Threaded Shank h8 Tolerance		Carbide Plain Shank h6 Tolerance		
		Morse Taper Shank MT 3 - 5								
Point Angle								Drill Point Angles		
		Countersink Angles 60° & 90°								
Lengths		Drills Stub Series		Drills Jobber Series		Drills Long Series		Drills Extra Length Series		
		End Mills Regular Series		End Mills Long Series						
Flute Helix Angle										Right hand helix
				Left hand helix						
Centre Drills		Form A Standard		Form B Protected		Form R Radius				
Inclination		To Suit 1 in 10 Taper		To Suit 1 in 50 Taper		To Suit 1 in 48 Taper				



ICON

LEGEND & DESCRIPTION

Threads	M Metric	MF Metric Fine	BSW British Standard Whitworth	BSF British Standard Whitworth Fine				
	UNC Unified National Coarse	UNF Unified National Fine	BSPT British Standard Pipe Taper "F" Series	BSP British Standard Pipe (Fine) "G" Series				
	NPS National Pipe Straight	NPT National Pipe Taper	BA British Association	BSB British Standard Brass				
	Thread Form - with 47½°/55°/60° flank angle							
Tolerance	h8 (d)	h8	k10	h10	k12	e8	Tolerance on cutting Diameter	
	wH6S d=h12	wH11 d=d11	Woodruff Tolerance		rH11 d1=js14	Corner Rounding Tolerance		
Application		Direction of Cut						
		Taper, Through & Blind Hole		Through & Blind Hole		Blind Hole Tapping		Through Hole Tapping
		Left Hand Cutting		Right Hand Cutting			Hand Taps	

GENERAL



MATERIAL DESCRIPTIONS

Materials	Code 0	Code 1	Code 2	Code 3	Code 4	Code 5	Code 7
Free Cutting Steels	x	x	x	x	x	x	x
Carbon Steel	x	x	x	x	x	x	x
Alloy Steel	x	x	x	x	x	x	x
Stainless Steel	x	x	x	x	x	x	x
Heat Resisting Alloys		x	x				
Nimonic Alloys				x	x	x	x
Titanium	x	x	x	x	x	x	x
Tool Steel				x	x	x	x
Cast Irons	x	x	x	x	x	x	x
Nickel	x						
Manganese Steels		x	x			x	x
Aluminium Alloys	x	x	x	x	x	x	x
Magnesium Alloys		x	x			x	x
Zinc Alloys						x	x
Copper	x	x	x	x	x	x	x
Synthetics / Plastics	x	x	x	x	x	x	x

Red Band Spiral Flute Taps for tapping Tough Treatable Steels

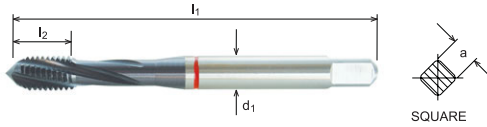



Size	Pitch	l_1	l_2	d_1	a	No. of Flutes	Code
M3	0.5	56	5	3.5	2.7	3	5640300
M4	0.7	63	7	4.5	3.4	3	5640400
M5	0.8	70	8	6	4.9	3	5640500
M6	1.0	80	10	6	4.9	3	5640600
M8	1.25	90	12.5	8	6.2	3	5640800
M10	1.5	100	15	10	8	4	5641000

Code

564

Properties

M	DIN 371	HSSE V3
ISO 2 6H		
CBA		TAIN

Suited Materials

TOUGH TREATABLE STEEL

TOOL STEEL
(ALLOY)

TITANIUM

Red Band Spiral Flute Taps for tapping Tough Treatable Steels

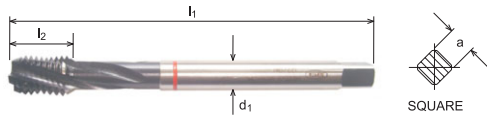



Size	Pitch	l_1	l_2	d_1	a	No. of Flutes	Code
M12	1.75	110	17.5	9	7	4	5761200
M14	2	110	20	11	9	4	5761400
M16	2	110	20	12	9	4	5761600
M18	2.5	125	25	14	11	4	5761800
M20	2.5	140	25	16	12	4	5762000
M22	2.5	140	25	18	14.5	4	5762200
M24	3	160	30	18	14.5	4	5762400

Code

576

Properties

M	DIN 376	HSSE V3
ISO 2 6H		
CBA		TAIN

Suited Materials

TOUGH TREATABLE STEEL

TOOL STEEL
(ALLOY)

TITANIUM



**THREADING
TOOLS**

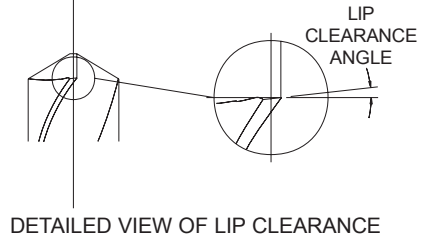
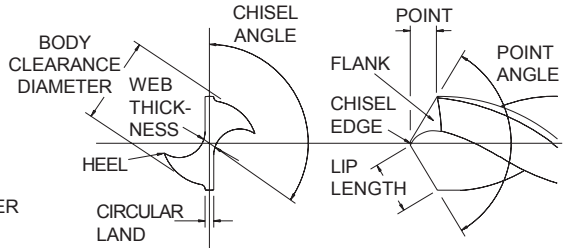
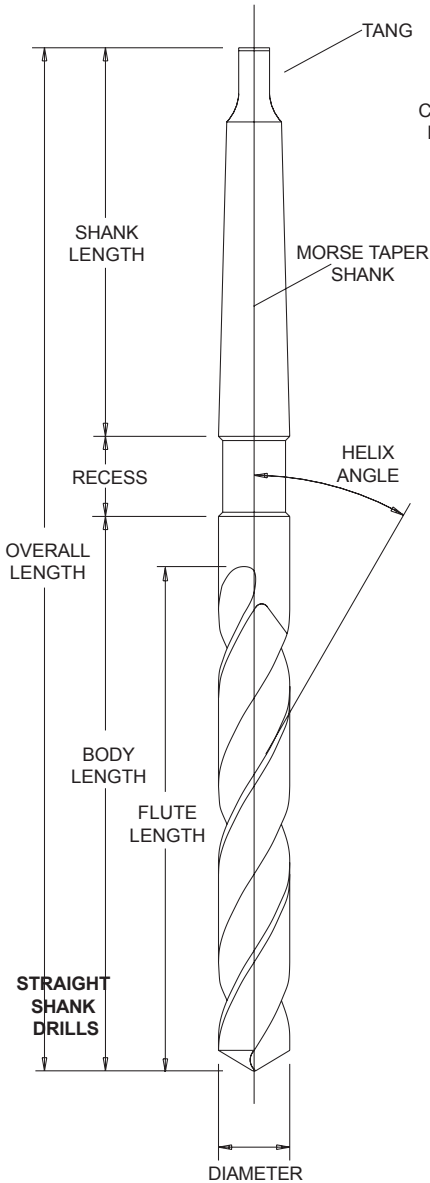

TYPES OF SPIRAL (OR HELIX) ANGLES

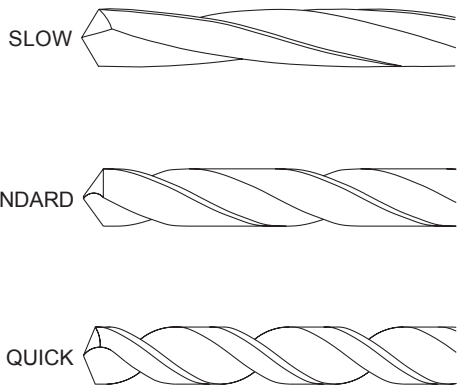

Note : Selecting the correct Drill
Refer to the User Guide for detailed information.

DRILL POINT STYLES

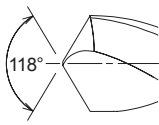

Standard Point

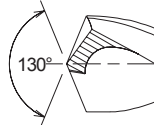
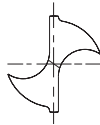

Split Point
Din 1412 Form C

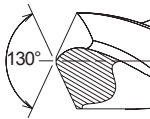
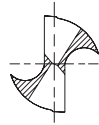

"UX Point"
DIN 1412 TYPE B

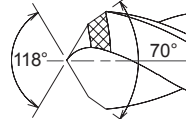
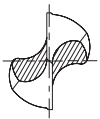

Cast Iron Point
"DX Point"
DIN 1412 TYPE D

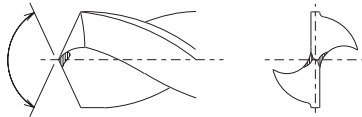
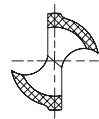

DIN 1412 TYPE A

FLUTE FORMS



- Conventional Web

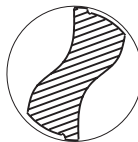

- Parabolic Flute Form
- Thicker Web



- Chipbreak SHANK DRILLS

Benefits of the Parabolic Flute Form

Heavy web construction increases rigidity under torsional load thus eliminating chatter at the cutting edges which cause edge break down and early failure. The Parabolic drill web is 50-90% thicker than the standard drill, depending on drill diameter.

Wider flute form, together with quicker spiral, promotes better chip removal while allowing easier coolant flow to the drill point.

STANDARD MORSE TAPER SHANK To I.S.O. 296 DIN228 BS1660

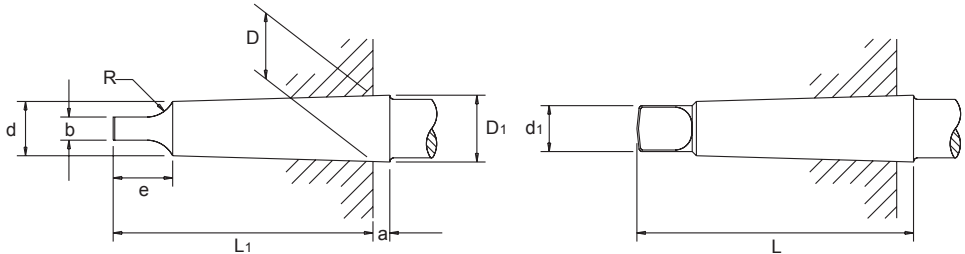

No. of Taper	Fitting line Diameter D	Diameter d	Overall Length Max L	D 1	a	Max L1	Max e	H13 b	Max d1	Taper / mm on Dia	Max R
1	12.065	9.0	65.5	12.2	3.5	62.0	13.5	5.2	8.7	0.04998	5.0
2	17.780	14.0	80.0	18.0	5.0	75.0	16.0	6.3	13.5	0.04995	6.0
3	23.825	19.0	99.0	24.1	5.0	94.0	20.0	7.9	18.5	0.05020	7.0
4	31.267	25.0	124.0	31.6	6.5	117.5	24.0	11.9	24.5	0.05194	8.0
5	44.399	36.0	156.0	44.7	6.5	149.5	29.0	15.9	35.7	0.05263	10.0
6	63.348	52.0	218.0	63.8	8.0	210.0	40.0	19.0	51.0	0.05214	13.0

HOW TO ORDER SPECIALS

MODIFIED STANDARDS

There are many instances when a special tool (a tool not found in the Somta catalogue or price list) can be manufactured from a standard product. We call this a 'modified standard'. Somta has both the capability and capacity to offer this service which, under normal circumstances, means a short delivery time.

The following are typical drill modifications:

Intermediate Diameters

Standard sizes can be ground down to special diameters and tolerances.

Reduced Overall Lengths

Standard drills can be cut to special lengths.

Drill Points

The standard drill point angle is 118° included. This can be modified to any angle required. Many special

points are available which include web thinning, notch points, split points, double angle points, spur and brad points etc.

Tangs and Flats

Tangs can be produced to DIN, ASA and ISO, also special whistle notch flats on shanks.

Step Drills

Standard drills can be modified into step drills.

Surface Treatments

A full range of surface treatments including nitriding, stream oxide, chemical blackening, gold oxide and various titanium coatings are available.

MULTIPLE DIAMETER DRILLS

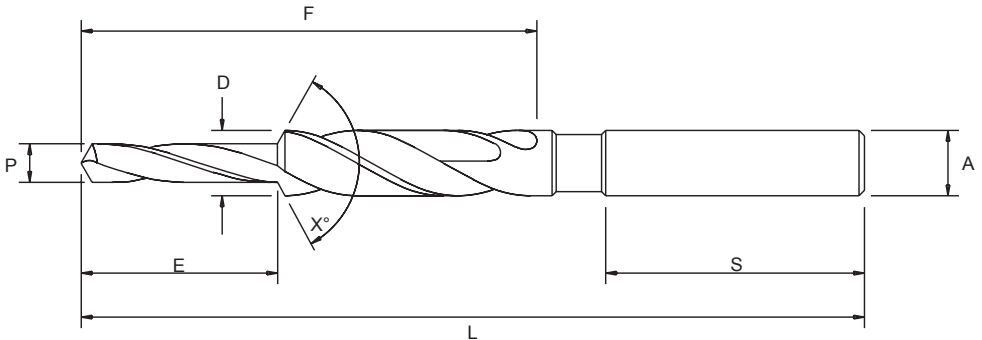

Specify whether drill is to be Step or Subland Type.

D = Diameter of large, fluted section.

P = Diameter of small, fluted section.

A = Shank Diameter.

L = Overall Length.

F = Flute Length.

E = Length of Small Diameter. This is measured from the extreme point to the bottom corner of the step angle.

X° = Included angle of the step angle.

S = Shank Length.

It is possible to drill two or more diameters in a hole on one operation with a correctly designed drill and these are often used in mass production engineering.

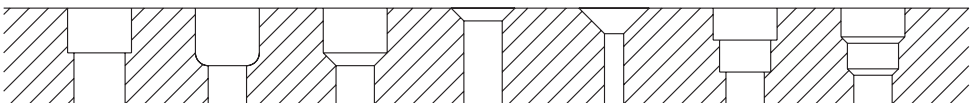

Some of the hole types that can be drilled in a single operation.

When an intermediate diameter or a non standard length of drill is required, the following diameters and lengths need to be specified.

Straight Shank Drills

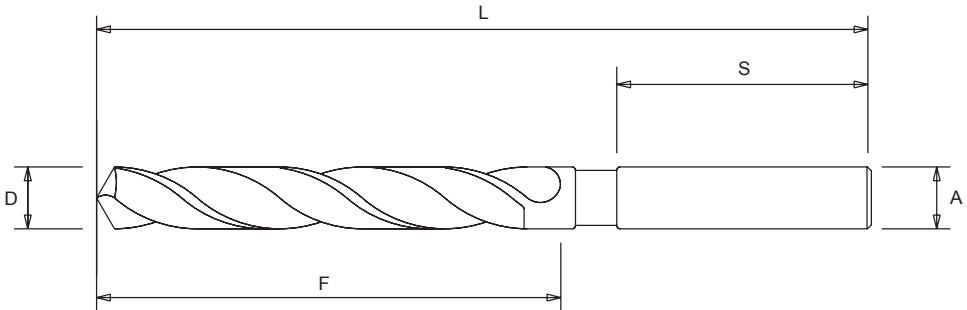

D = Drill Diameter
A = Shank Diameter
L = Overall Length
F = Flute Length
S = Shank Length

Morse Taper Shank Drills

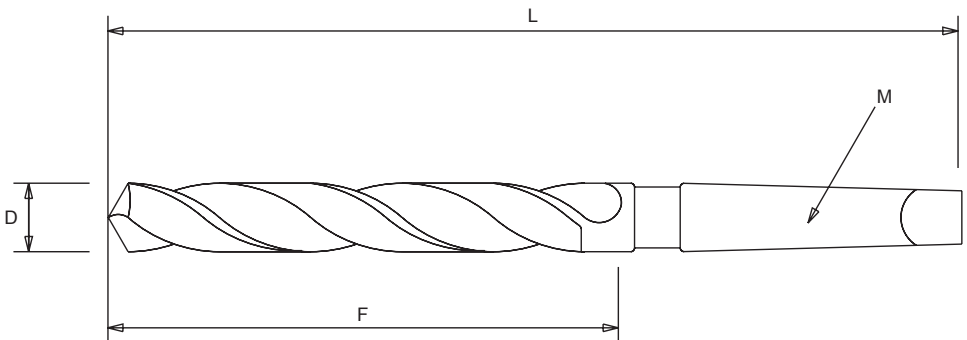

D = Drill Diameter
L = Overall Length
F = Flute Length
M = Morse Taper Size